

Dual Power HiPerFET™ Module

Phaseleg Configuration

$V_{DSS} = 900\text{ V}$
 $I_{D25} = 85\text{ A}$
 $R_{DS(on)} = 76\text{ m}\Omega$

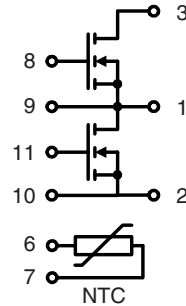

MOSFET T1 + T2

Symbol	Conditions	Maximum Ratings	
V_{DSS}	$T_{VJ} = 25^{\circ}\text{C to } 150^{\circ}\text{C}$	900	V
V_{GS}		± 20	V
I_{D25}	$T_C = 25^{\circ}\text{C}$	85	A
I_{D80}	$T_C = 80^{\circ}\text{C}$	65	A
I_{F25}	(diode) $T_C = 25^{\circ}\text{C}$	85	A
I_{F80}	(diode) $T_C = 80^{\circ}\text{C}$	65	A

Features

- HiPerFET™ technology
 - low $R_{DS(on)}$
 - unclamped inductive switching (UIS) capability
 - dv/dt ruggedness
 - fast intrinsic reverse diode
 - low gate charge
- thermistor for internal temperature measurement
- package
 - low inductive current path
 - screw connection to high current main terminals
 - use of non interchangeable connectors for auxiliary terminals possible
 - Kelvin source terminals for easy drive
 - isolated DCB ceramic base plate

Symbol	Conditions	Characteristic Values ($T_{VJ} = 25^{\circ}\text{C}$, unless otherwise specified)		
		min.	typ.	max.
$R_{DS(on)}$	$V_{GS} = 10\text{ V}; I_D = I_{D80}$			76 m Ω
$V_{GS(th)}$	$V_{DS} = 20\text{ V}; I_D = 30\text{ mA}$	3		5 V
I_{DSS}	$V_{DS} = 0.8 \cdot V_{DSS}; V_{GS} = 0\text{ V}; T_{VJ} = 25^{\circ}\text{C}$ $T_{VJ} = 125^{\circ}\text{C}$		1.5	0.4 mA mA
I_{GSS}	$V_{GS} = \pm 20\text{ V}; V_{DS} = 0\text{ V}$			1 μA
Q_g Q_{gs} Q_{gd}	$V_{GS} = 10\text{ V}; V_{DS} = 450\text{ V}; I_D = 50\text{ A}$		960	nC
			225	nC
			430	nC
$t_{d(on)}$ t_r $t_{d(off)}$ t_f	$V_{GS} = 10\text{ V}; V_{DS} = 0.5 \cdot V_{DSS};$ $I_D = I_{D80}; R_G = 0.47\ \Omega$		150	ns
			180	ns
			330	ns
			140	ns
V_F	(diode) $I_F = 90\text{ A}; V_{GS} = 0\text{ V}$		1.1	1.6 V
t_{rr}	(diode) $I_F = 90\text{ A}; -di/dt = 400\text{ A}/\mu\text{s}; V_{DS} = 100\text{ V}$		250	ns
R_{thJC} R_{thJS}	with heat transfer paste		0.12	0.08 K/W K/W

Applications

- converters with high power density and high switching speed for
 - power supplies
 - induction heating

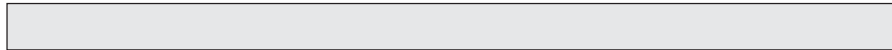

Symbol	Conditions	Characteristic Values		
		min.	typ.	max.
R_{25}	$T = 25^{\circ}\text{C}$		2200	Ω
$B_{25/100}$			3560	K

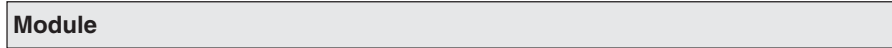

Symbol	Conditions	Maximum Ratings	
T_{VJ}		-40...+150	$^{\circ}\text{C}$
T_{stg}		-40...+125	$^{\circ}\text{C}$
V_{ISOL}	$I_{ISOL} \leq 1 \text{ mA}; 50/60 \text{ Hz}$	3600	V~
M_d	Mounting torque (M6)	2.25 - 2.75	Nm
	Terminal connection torque (M6)	4.5 - 5.5	Nm

Symbol	Conditions	Characteristic Values		
		min.	typ.	max.
Weight			250	g

Dimensions in mm (1 mm = 0.0394")

Optional accessories for modules

keyed twin plugs
(UL758, style 1385, CSA class 5851, guide 460-1-1)

- Type ZY180L with wire length 350mm
– for pins 4 (yellow wire) and 5 (red wire)
– for pins 11 (yellow wire) and 10 (red wire)
- Type ZY180R with wire length 350mm
– for pins 7 (yellow wire) and 6 (red wire)
– for pins 8 (yellow wire) and 9 (red wire)

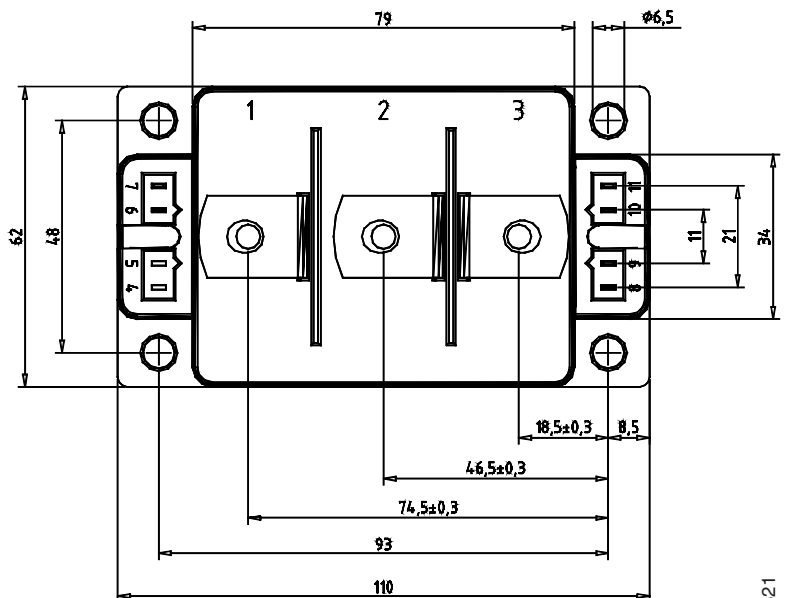
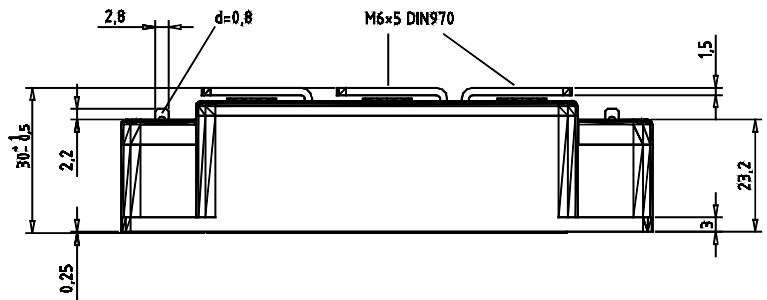

IXYS reserves the right to change limits, test conditions and dimensions.

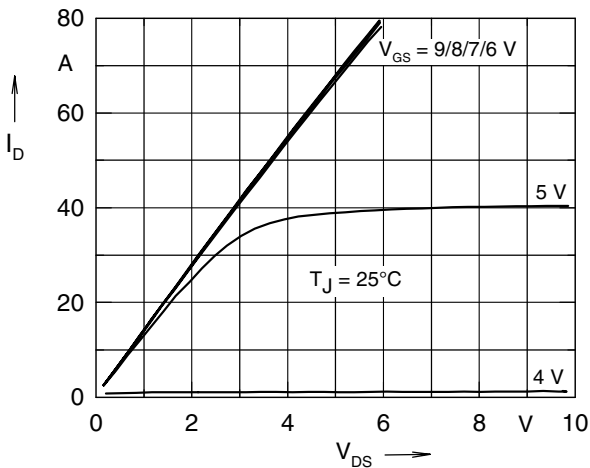

Fig. 1 Typical output characteristics

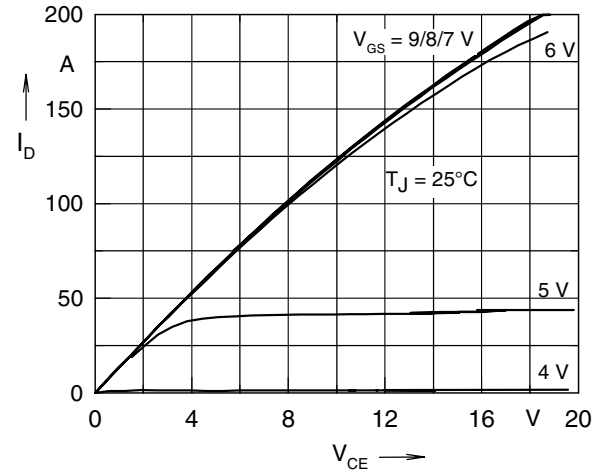

Fig. 2 Typical transfer characteristics

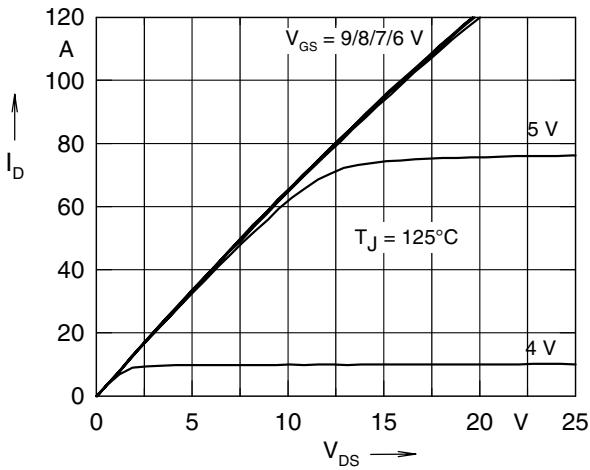

Fig. 3 Typical output characteristics

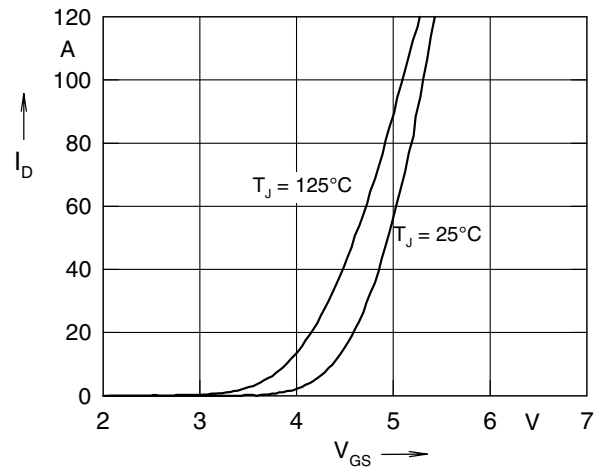

Fig. 4 Typical transfer characteristics

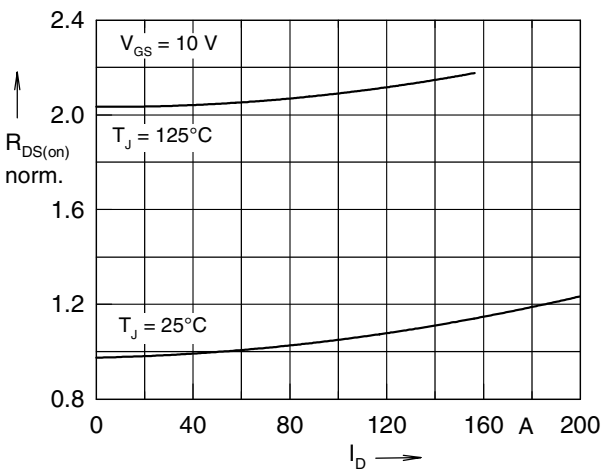

Fig. 5 Typical normalized $R_{DS(on)}$ versus I_D

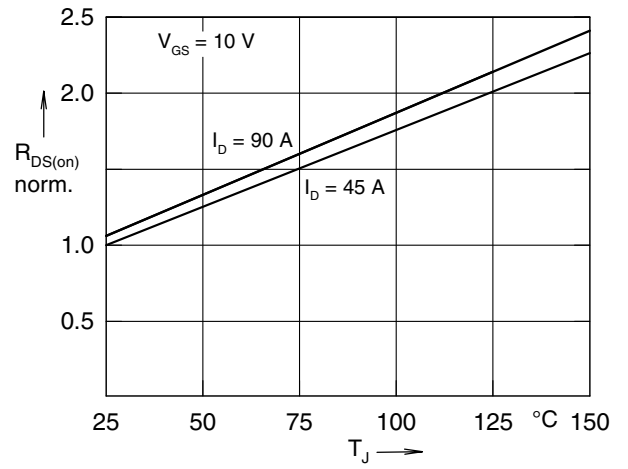

Fig. 6 Typical normalized $R_{DS(on)}$ versus T_J

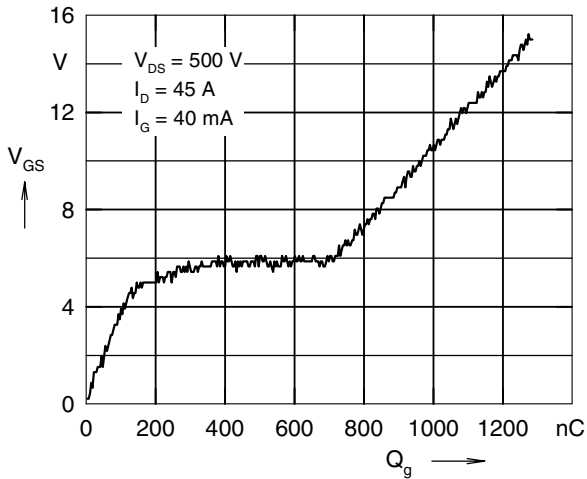

Fig. 7 Typical turn-on gate charge characteristics

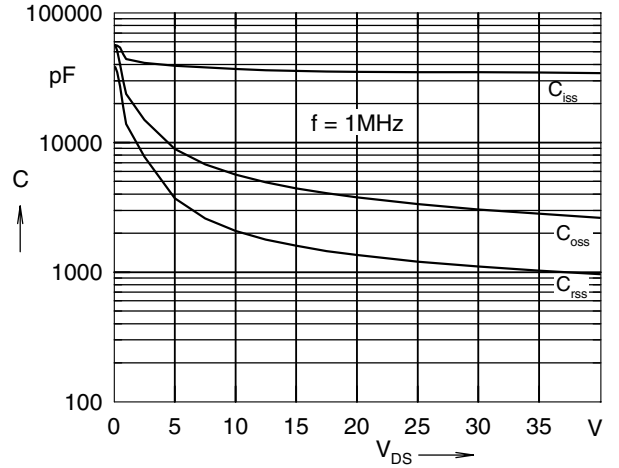

Fig. 8 Typical capacitances

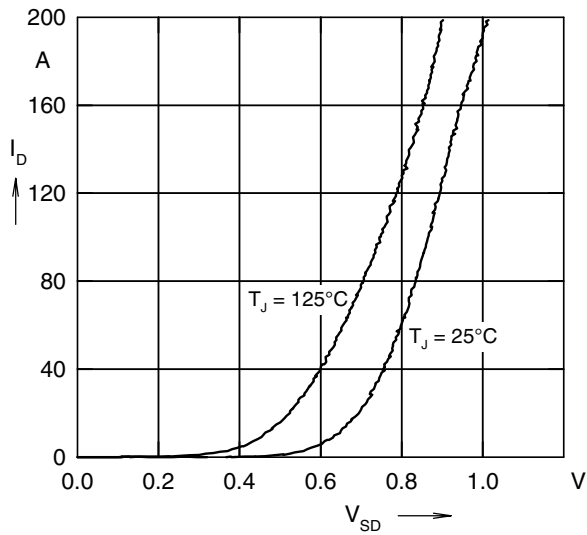

Fig. 9 Typical forward characteristics of diode

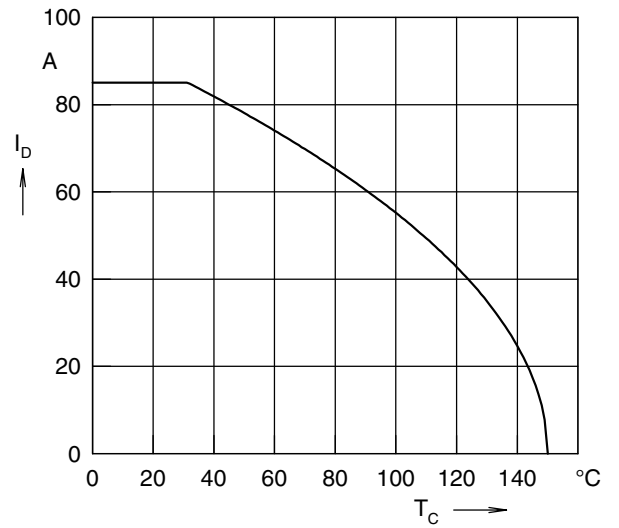

Fig. 10 Continuous drain current

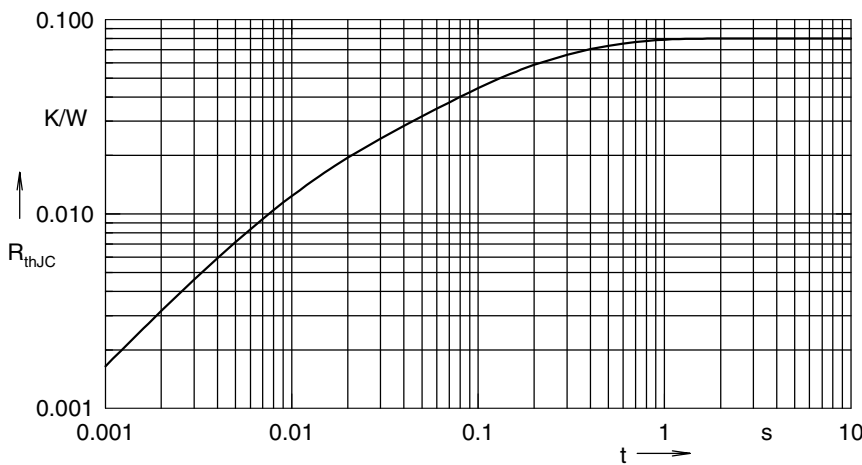

Fig. 11 Transient thermal resistance